

OPERATOR'S MANUAL

WITH WARRANTY & PARTS LIST FOR

STEEL DRI-FLO™

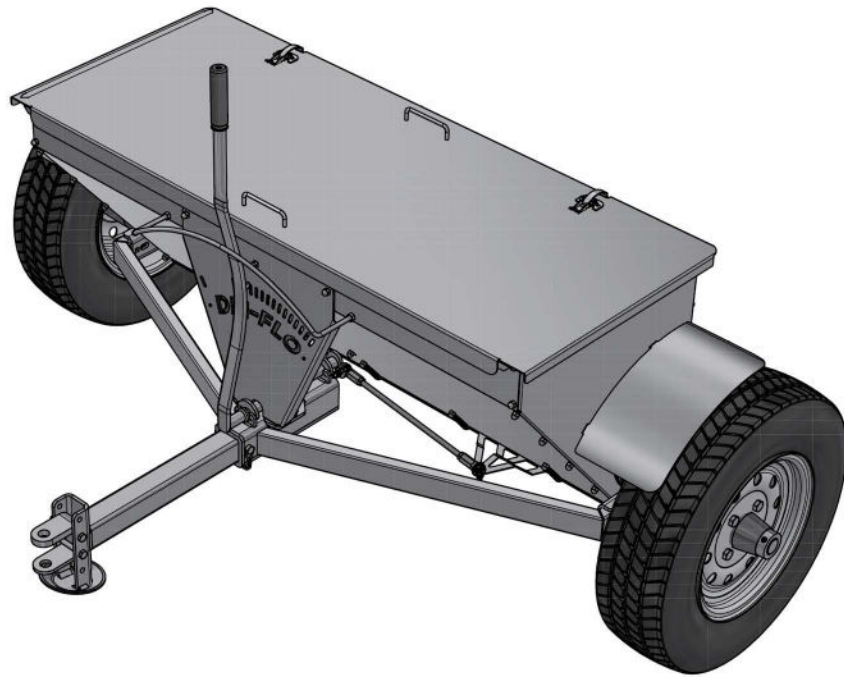

DROP SPREADERS

Dri-Flo™ Precision Models 36", 48" & 60"

Earth & Turf

America's Compact Drop Spreader Company

Drop Spreaders:
Dri-Flo™ Precision Models 36", 48" & 60"

LIMITED WARRANTY

Earth & Turf Products, LLC of Kirkwood, PA, warrants to the original purchaser a guarantee that each product it manufactures is free from defects in both material and workmanship, if properly serviced and operated under normal conditions, for 365 days from the date of purchase.

Components installed in the unit which are not manufactured by Earth & Turf Products, LLC will be covered under the terms spelled out by each manufacturer, unless otherwise stated.

Earth & Turf Products, LLC is committed to correct defect(s), without charge only when the work is done at the place of manufacture, or at one of the Earth & Turf's authorized dealers and/or service centers.

Transportation charges to and from the point of service will be the responsibility of the purchaser.

All warranty claims will be subject to examination by Earth & Turf Products, LLC. Replacement and/or repair of defect(s) will be considered by Earth & Turf Products, LLC to have satisfied the obligation to the original purchaser.

Earth & Turf Products, LLC shall not be made liable for any incidental or consequential damages, under any circumstances arising from loss or other damages or losses owing to the failure or use of Earth & Turf's products beyond the cost of repair or replacement of any defective parts.

Earth & Turf Products, LLC will not recognize any warranties extending beyond 365 days on Precision models. Any extended warranties created by dealers must heretofore be authorized in writing by an officer of Earth & Turf Products, LLC.

**WARRANTY CLAIM FORMS CAN BE OBTAINED
BY CONTACTING EARTH & TURF PRODUCTS, LLC**

Earth&Turf

Manufacturers of Compact Manure Spreaders and Drop Spreaders
1867 Kirkwood Pike • Kirkwood, PA 17536 • Phone (717) 529-0199 • Fax (717) 500-1036

INTRODUCTION

GUIDE TO THIS MANUAL

This manual contains all the information necessary to safely operate the Earth & Turf Drop Spreaders. Should any questions arise, please contact Earth & Turf Products or your Dealer before using this equipment.

Regarding the information presented in this manual: All safety, operating and service information reflect current production units at the time this manual was published.

References made to Left, Right, Front or Rear are directions given when you are facing the unit from the rear.

Please read this entire manual carefully before operating this unit: doing so will ensure your safety and prolong the high performance of the equipment.

FOR YOUR SAFETY

This manual contains the following Safety Statements, listed separately here to impress upon you their importance:

- **NOTE:** A clarification of information previously stated or additional pertinent information.
- **ATTENTION:** A safety statement indicating that potential damage to the equipment may occur if instructions are not followed.

 **CAUTION:** A Safety Statement which reminds you of a good safety practice and/or directs your attention to an unsafe practice which could result in Personal Injury.

 **WARNING:** A Strong Safety Statement; indicating that a Hazard exists which may result in Injury or Death if proper procedures are not followed.

 **DANGER:** The utmost level of safety must be observed; an extreme hazard exists which will result in the high probability of death or irreparable serious personal injury if proper precautions are not taken.

The best equipment operator is a careful operator. By using common sense, observing the safety rules and adhering to the precautions specific to this spreader, you the operator can expect this unit to provide

many hours of carefree service.

In addition to observing the specific precautions listed throughout this manual, the following general precautions apply and must be adhered to in order to ensure safe and proper operation of this equipment.

 **WARNING:** Keep hands and feet from under the spreader at all times. Be sure other persons are at a safe distance from the equipment before operating the unit.

 **WARNING: Do Not** attempt to operate the spreader in areas with steep inclines, ditches, large rocks, stumps or holes which may endanger the operator by upsetting the tractor or causing damage to the spreader.

 **CAUTION:** To prevent injury and promote safe spreader operation, keep all shields in place during operation. Ensure that all mounting hardware is properly tightened.

 **WARNING:** Never clean, adjust or repair the spreader while the tractor is running.

 **WARNING:** Never get off the tractor while it is in motion and/or the spreader is in operation.

 **WARNING:** Never wear loose clothing when operating the spreader as it may become caught in the moving parts of the machine.

 **WARNING:** Never allow children or anyone else to ride on the spreader.

 **ATTENTION:** To ensure proper and safe operation of the spreader, periodically inspect all parts for excessive wear. Replace worn components with factory authorized parts.

Safety Decals have been placed on your spreader to remind you of the critical safety precautions which must be heeded to ensure the personal safety to you the operator, and any persons in the vicinity of the equipment while it is in operation. Be sure to keep the Safety Decals clean and readable. If the decals ever become damaged or illegible, contact your Conestoga dealer for replacements.

SAFETY DECALS

The safety decals appearing below are a sample of those affixed to the Earth & Turf Drop Spreader. These examples are not meant to represent all decals, but to illustrate typical precautionary and informational signage relating to the Earth & Turf Drop Spreader operation and use.

IMPORTANT: It is the responsibility of the operator to locate, read, and adhere to all information provided on all decals affixed to the unit being operated.



WARNING

NEVER leave operating position without turning off the engine & removing the key.

Apparatus is not designed for use at speeds greater than 8 mph while engaged.

DO NOT back up while apparatus is engaged.

FAILURE TO FOLLOW ALL THE INSTRUCTIONS MAY RESULT IN SERIOUS BODILY INJURY OR DEATH.



WARNING

NEVER turn on or engage the apparatus with someone standing in close proximity to any movable part of the apparatus.

NEVER ride this apparatus.

FAILURE TO FOLLOW ALL THE INSTRUCTIONS MAY RESULT IN SERIOUS BODILY INJURY OR DEATH.

OPERATION & TROUBLE SHOOTING

OPERATION

Before proceeding with the operation of the spreader, review all of the safety statements.

ATTENTION: In order to obtain proper spreading action, the spreader must reach a ground speed of three miles per hour (this amounts to a comfortable walking pace). Spreading at speeds higher than eight miles per hour (this amounts to a very brisk walking pace) can cause excessive wear and/or damage to the equipment.

SETUP INSTRUCTIONS

- 1.** Take out of crate.
- 2.** Mount tire and wheels using a 3/4" socket to engage lug bolts (4 lug bolts on each side). Lug bolt recommended torq specs are 90-120.
- 3.** Extend the adjustable hitch to a comfortable length (item #2 in parts breakdown). Assure towing vehicle was an applicable hitch and pin. Recommended hitch pin size is 5/8" diameter x 4" long.
- 4.** Try to keep the machine hitch as close to level as possible by adjusting the height of the adjustable hitch (item #35 in parts breakdown).
- 5.** A calibration chart should be on inside of lid. Calibration chart is approximate as materials vary in density and moisture content.
- 6.** Recommended speeds are disengaged 10 mph, engaged 5 mph.

TROUBLE SHOOTING

If auger jams up and wheels slide, check for rocks or other objects in your material.

If material does not flow properly, material may be wet. If you can squeeze the material and it does not fall apart, it is too wet to flow properly.

If material starts to push screen away from the box bottom, remove springs on front side and clean out the material, and then put springs back on screen.

If screen fails to close all the way, you can adjust item #36 and #37 on the parts breakdown to better line up screen to bottom of box.

If wheels fail to drive and there is no clicking sound when backing up, items #31 and #32 may have failed. You may have to replace these; call the manufacturing company for parts.

GREASE LUBRICATION SCHEDULE

ATTENTION: Worn grease fittings which will not receive the gun and/or fittings with a stuck check valve must be replaced. All fittings are SAE standard. Lubricate all non-sealed fittings until grease begins to seep from the fitting. Use a multi-purpose grade grease. Grease points are as follows:

Total of 4 grease fitting points per unit with one agitator, 8 with the second agitator.

Grease point with Label "B" required 3 pumps every 10 hours of use.

Grease point with Label "A" required 2 pumps every 200 hours of use.

Label "C" 2 points; Oil all roller chains semi-annually.
(Roller chains are only on units with the second agitator)

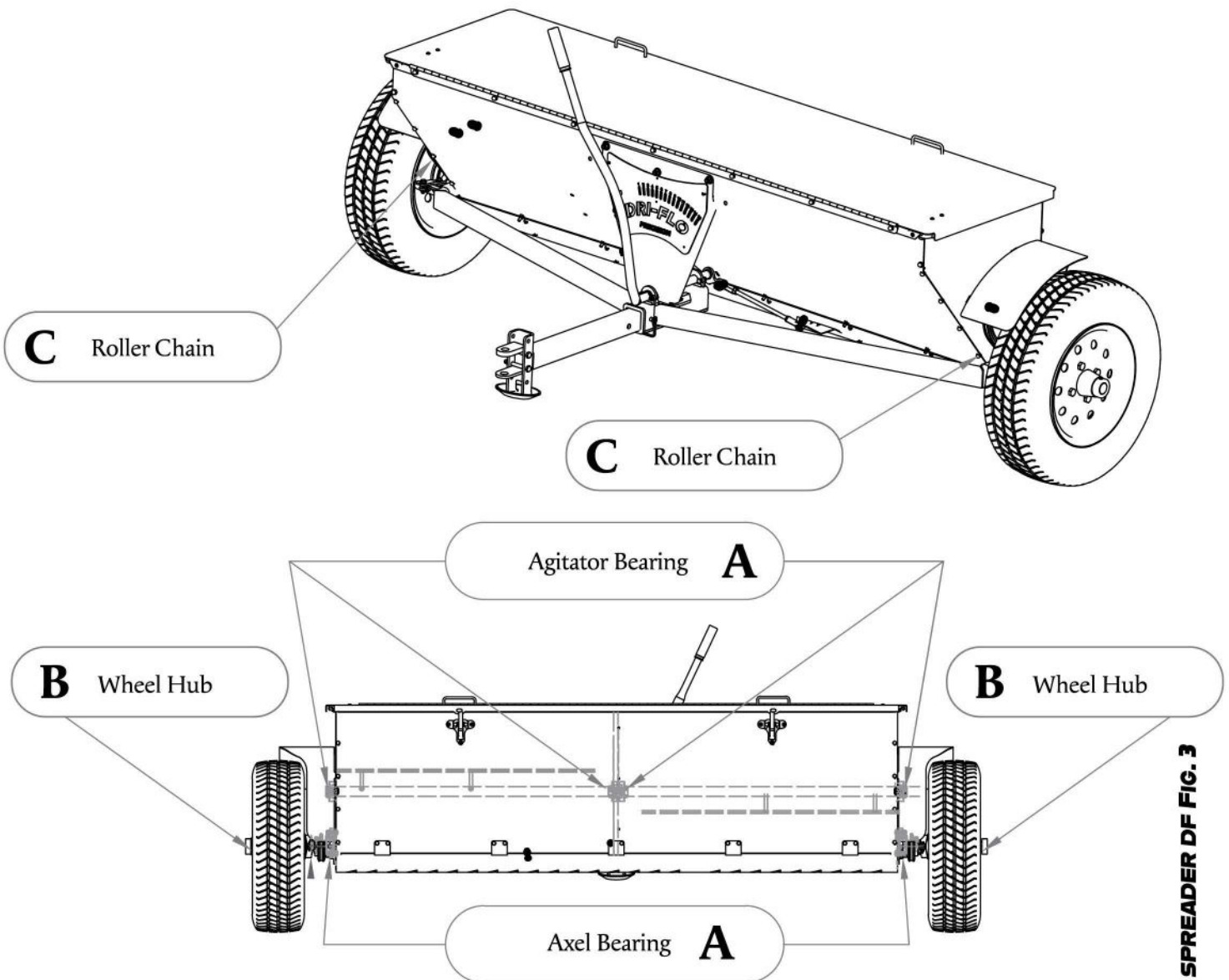

DROP SPREADER DF FIG. 3

MAINTENANCE

MAINTENANCE & LUBRICATION

WARNING: All Shields that have been removed must be replaced after lubrication, maintenance or adjustments are performed.

By performing regular lubrication & maintenance, you will ensure continued high performance from your Earth & Turf Spreader.

- Clean the spreader after each use.
- Check the spreader before use for loose, bent, or broken parts.

ATTENTION: During operation, listen for abnormal sounds which might indicate loose parts or equipment damage. Correct any problems immediately. Refer to the parts break-down drawings on pages 10 & 11 of this manual.

CLEANING

Check your lubricating schedule. After using machine, always wash out the interior of the box.

Check for loose bolts and missing shields and tighten them.

Never leave material in box for more than a few days. If there is any moisture, it can become solid and create problems.

Always make sure all shields are in place and tightened before each use.

RECOMMENDED MATERIALS:

- Lime granular, powdered, dry ag lime hydrated
- Fertilizer
- Seeds
- Fine ice control

NOT RECOMMENDED MATERIALS:

- Sand
- Wet ag lime
- Gravel
- Rock salt

CAUTIONS

While the machine is full of materials and unhitched, the spreader may be hard to steer, push, and control. Flipping back of the machine is possible if hitch is lifted to high.

The spreader is likely wider than the towing vehicles. Be sure to keep track of the width towing behind.

RECOMMENDED TRAVEL SPEED:

- Disengaged 10 mph
- Engaged 5 mph

PART NUMBERS

ITEM	QTY	PART NUMBER	DESCRIPTION (48" Model Shown)	36DF	48DF	60DF
1	1	CMP-DF100206	Hitch Assy			
2	1	CMP-DF100205	Coupler Assy			
3	1	CMP-DF100146	Locking Pin MC 98416A531			
4	1	CMP-DF100209	Auger Assembly 48"	36"	48"	60"
5	2	CMP-DF100148	Roller Chain 50 x 54 Links			
6	2	CMP-DF100123	50 X 40 Sprocket			
7	2	CMP-DF100121	50 W15H SPROCKET GTH			
8	2	CMP-DF100132	Tire			
9	1	CMP-DF100126	Handle Guard			
10	2	CMP-DF100210	Auger Mixer 48"	36"	48"	60"
11	1	CMP-DF1005	48" Lid	36"	48"	60"
12	2	CMP-DF100139	4" Handle SH 4484 AL			
13	2	CMP-DF100124	Hood Latch HR-1			
14	1	CMP-DF1009 R	Box End R			
15	1	CMP-DF1003	48" Box	36"	48"	60"
16	1	CMP-DF10010	Baffle			
17	1	CMP-DF10011	Face Plate (TANGO) Font			
18	2	CMP-DF100118	Pillow Block SBRFT SB206-20 KML			
19	4	CMP-DF100125	Pillow Block BLF 206-6G KML			
20	2	CMP-DF1023	Chassis Plate			
21	1	CMP-DF1009 L	Box End L			
22	1	CMP-DF1004	48" Screen	36"	48"	60"
23	4	CMP-DF1028	Screen Clip			
24	1	CMP-DF1027 R	Fender R			
25	1	CMP-DF1027 L	Fender L			
26	5	CMP-DF100129	Screen Extension Spring MC 94135K21			
27	1	CMP-DF1033	Face Plate Background			
28	8	ANSI B18.2.1 - 1/2-13 UNC - 0.75	Wheel Lugs			
29	2	CMP-DF100119	Wheel Ratchet Inner Hub			
30	2	CMP-DF100120	Wheel Ratchet Outer Drum			
31	2	CMP-DF100150	Clutch Ratchet Pawl			
32	2	CMP-DF100151	Clutch Paw Spring			
33	2	CMP-DF100140	Shaft Collar MC 6432K29			
34	1	CMP-DF100204	Handle Assy			
35	1	CMP-DF10021	Drawbar Assy			
36	2	CMP-DF100127	CF6 Female Rod End			
37	1	CMP-DF100128	Threaded Rod 0.375-24			
38	1	CMP-DF100106	Hand Grip MC9729K21			
39	2	CMP-DF1014	Clamp 1			

PART NUMBERS

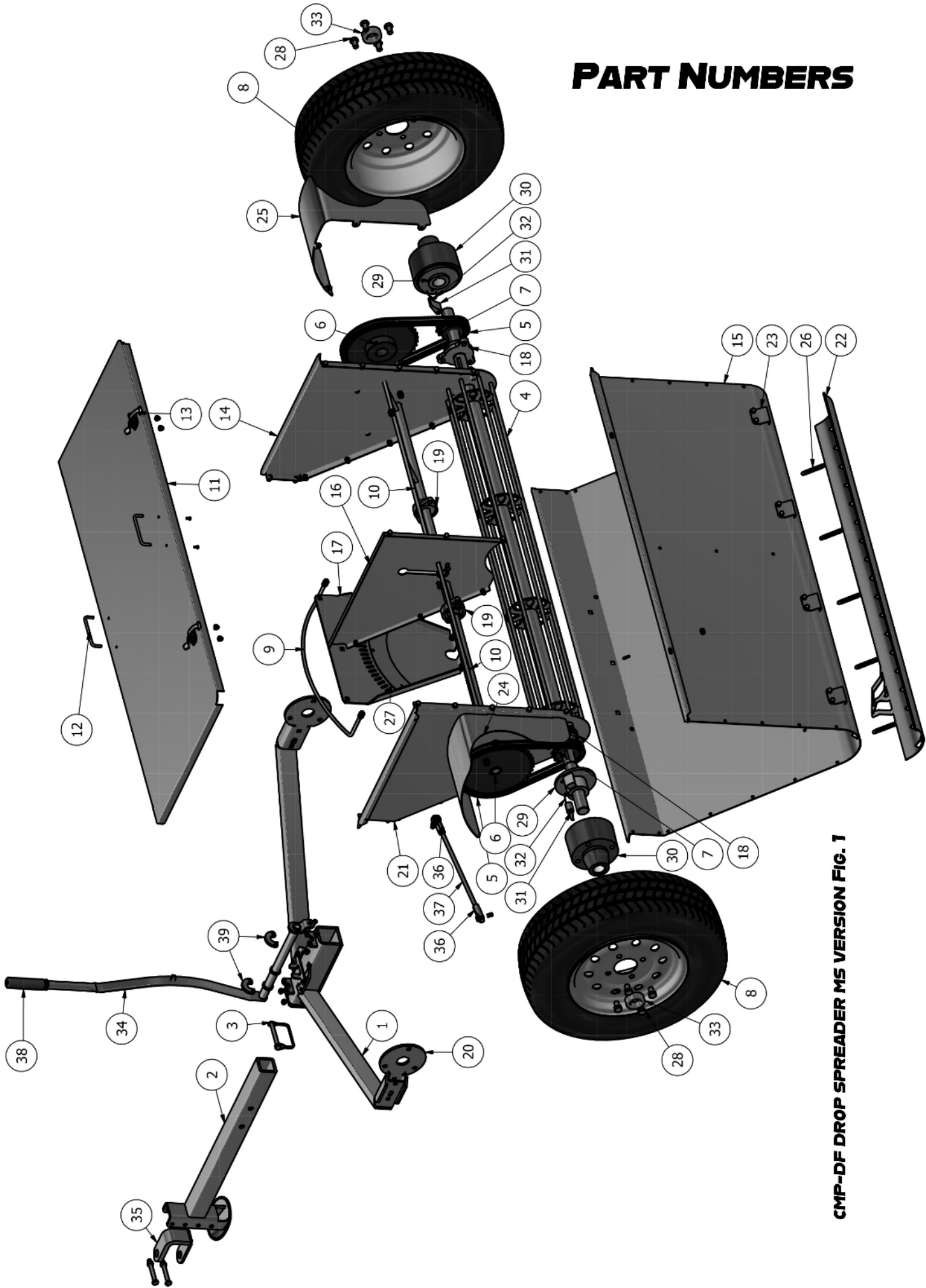

CMP-DF DROP SPREADER MS VERSION FIG. 1

SPECIFICATIONS

DESCRIPTION	MODEL 36DF	MODEL 48DF	MODEL 60DF
Spread Calibration (Holes)	1.75 in. W x 1.25 in. L (Triangle Shape)		
Hopper Opening	18.5 in. Length (Front to Back)		
Hopper Depth	22 in. Deep (Front to Back)		
Tire Size	23 x 8.5 - 12 in.		
Box Material	14 Ga. Steel		
Flow Settings	15 Settings		
Axle Size	1.25 in. Solid Steel		
Overall Width	60 in.	73 in.	85 in.
Straddle Width	43 in.	55 in.	66 in.
Ground Clearance	7.5 in.		

RATE CHART CALIBRATION SETTINGS

Settings are lbs. per 1000 sq. ft.	Gauge Settings	1	2	3	4	5	6	7	8	9	10	11	12	13	14	15	
	Ag Lime	5.8	9.4	15.7	22.0	25.2	33.1	40.6	50.0	56.4	64.2	74.5	85.0	98.2	112.0	128.0	
For lbs. per acre, take lbs. per 1000 sq. ft. x 43.6	Damp Ag Lime	.36	1.06	2.0	3.3	4.3	5.6	7.6	9.3	12.5	18.3	19.7	25.6	32.7	39.2	42.6	
	Pelletized Lime	3.8	7.0	17.5	34.7	42.8	46.5	72.6	90.1	108.0	135.0						
	Fine Granular Fertilizer	.88	4.2	10.4	21.2	34.3	51.0										
Travel speed 3-4 mph	Medium Granular Fertilizer	1.1	6.16	13.6	23.6	36.1	54.1										
	Seed Mix - 70% Rye Grass	.18	1.6	3.8	5.4	9.6	14.7	20.9									

*Rate chart settings are approximate due to different density, texture and moisture contents.
It is your responsibility to ensure that each material is properly calibrated.

Earth&Turf

CONESTOGA MANUFACTURING, LLC.

1867 KIRKWOOD PIKE

KIRKWOOD, PA 17536

717-529-0199